

4JH4-TE Series

Configuration	4-stroke, vertical, water-cooled diesel engine		
Maximum output at crankshaft	* 55.2 kW@3200 rpm	[75 mhp@3200 rpm]	
Displacement	1.995 ltr	[121.7 cu in]	
Bore x stroke	84 mm x 90 mm	[3.31 in x 3.54 in]	
Cylinders	4, 4-valves per cylinder		
Combustion system	Direct injection		
Aspiration	Turbocharged		
Starting system	Electric starting 12V - 1.4 kW		
Alternator	12V - 80A		
Cooling system	Fresh water cooling by centrifugal water pump and rubber impeller sea water pump		
Lubrication system	Enclosed, forced lubricating system		
Direction of rotation [crankshaft]	Counterclockwise viewed from flywheel side		
Dry weight without gear	207 kg	[456 lbs]	
Environmental	EU: RCD	BSO II	EMC
	US: EPA Tier 3		
Engine mounting	Rubber type flexible mounts		

NOTE:

Fuel condition: Density at 15°C = 0.84 g/cm³; 1 kW = 1.3596 mhp = 1.3410 HP

* Fuel temperature 40° C at the inlet of the fuel injection pump [ISO 8665]

Technical data is according to ISO 8665: 2006/3046-1

DIMENSIONS

Rear view

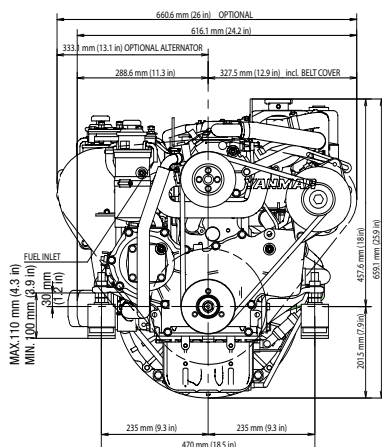

Right side view

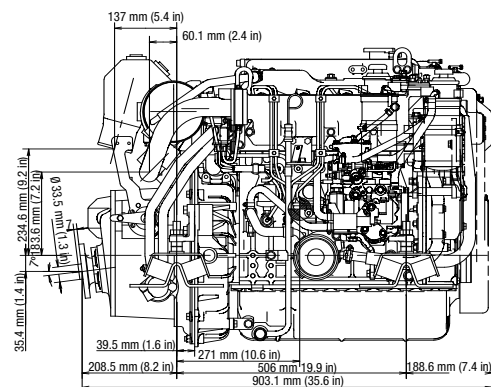

4JH4-TE with KM4A2 marine gear

PERFORMANCE CURVES

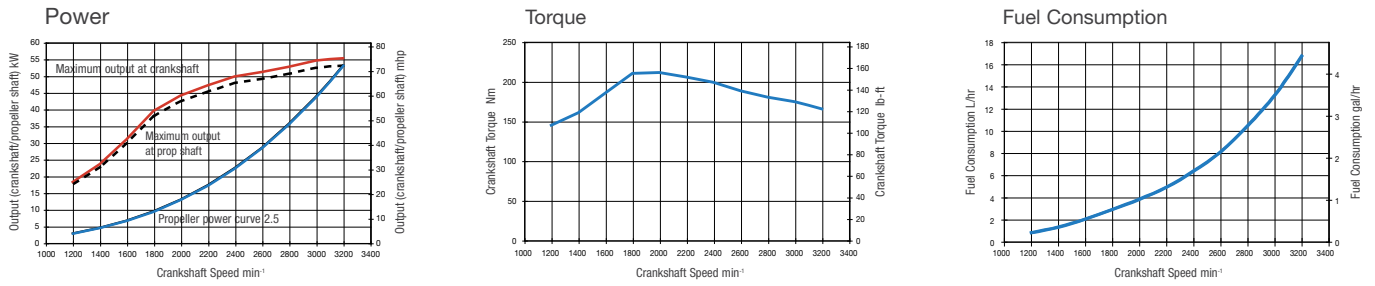

MARINE GEARS/DRIVE

Model	ZF30M parallel	KM4A2 [down angle: 7°]	KMH4A [down angle: 8°]	ZF25A [down angle: 8°]	Saildrive SD60
Type	Mechanical multi-disc	Mechanical wet cone clutch	Hydraulic, wet multi-disc	Hydraulic, wet multi-disc	Mechanical wet type multi-disc
Dry Weight	28 kg [61 lbs]	30 kg [66 lbs]	31 kg [68 lbs]	30 kg [66 lbs]	42 kg [92 lbs]
Reduction Ratio [fwd/asn]	2.15/2.64 2.70/2.64	1.47/1.47 2.14 / 2.14 2.63/2.63	2.04/2.04 2.45/2.45	1.93/1.93 2.48/2.48	2.23/2.23 2.49/2.49
Propeller speed at cont. rating [fwd/asn]	1488/1212 1185/1212	2177/2177 1495/1495 1217/1217	1569/1569 1306/1306	1658/1658 1290/1290	1435/1435 1285/1285
Direction of rotation [propeller shaft - fwd]	Clockwise viewed from flywheel side	Clockwise & Counterclockwise viewed from flywheel side	Clockwise & Counterclockwise viewed from flywheel side	Clockwise & Counterclockwise viewed from flywheel side	Clockwise & Counterclockwise viewed from flywheel side
Dry weight - engine & gear	235 kg [518 lbs]	237 kg [522 lbs]	238 kg [524 lbs]	237 kg [522 lbs]	249 kg [549 lbs]
Length engine and gear/drive	923 mm [36 in]	903 mm [35 in]	933 mm [37 in]	1017 mm [40 in]	1148 mm [45 in]

INSTRUMENT PANELS

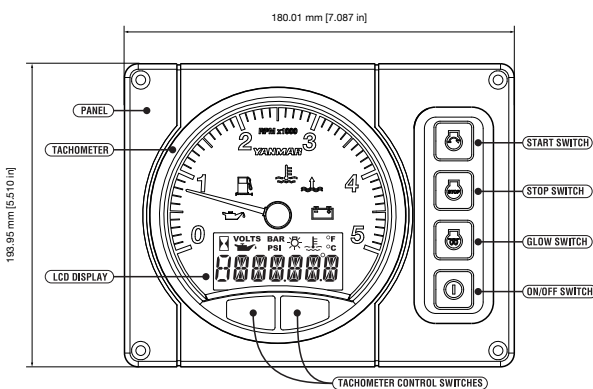

B20 STANDARD

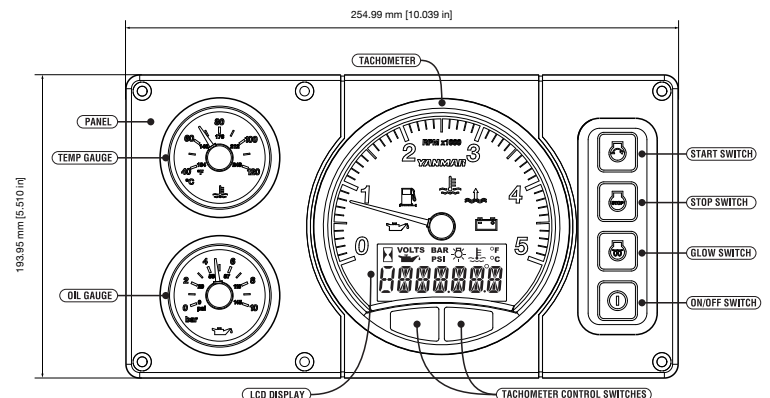

C30 OPTIONAL

ACCESSORIES

Standard Package

- Set of flexible mounts
- Exhaust mixing elbow [L-type]
- V-belt safety cover
- Expansion tank for fresh water cooling system
- Alternator 12V - 125A
- Electric stop solenoid
- Operation manual
- B20-panel
- Sensor for instrument panel

Optional

- Digital B or C type instrument panel
- Second Alternator 12V - 130A or 24V - 75A, including smart regulator
- High-riser mixing elbow [instead of L-elbow]
- Extension wire harness [4m, 6m, 10m]
- Hot water kit with cocks
- Second station harness
- C30-panel
- Sensor for C30-panel
- Extension saildrive leg [75mm]
- Propeller cone nut kit SD60

NOTE: All data subject to change without notice. Text and illustrations are not binding.