

# OWNER'S MANUAL

 TOHATSU

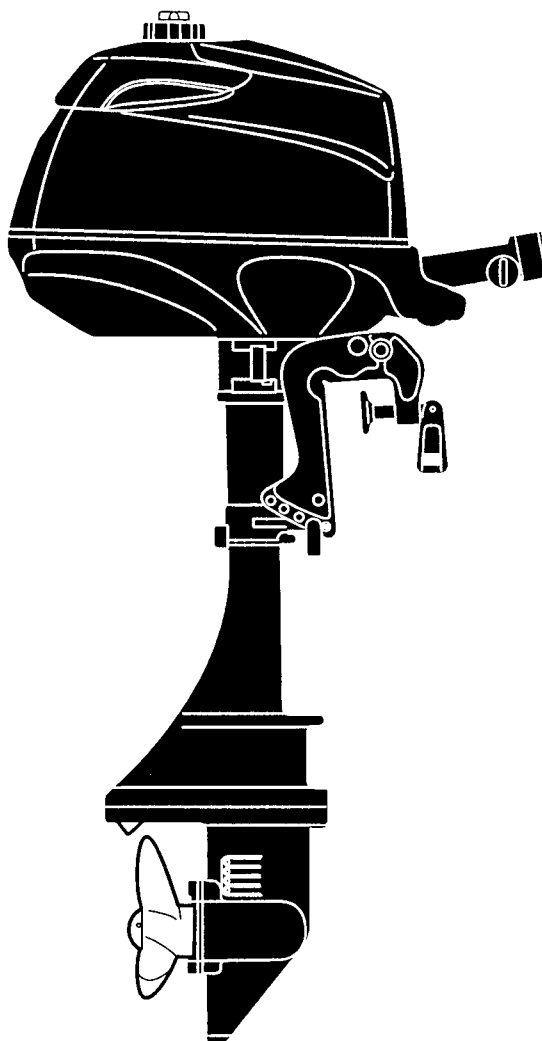

**MFS 2**  
**3.5**

No.003-11086-0

**Copyright © 2007 Tohatsu Corporation. All rights reserved. No part of this manual may be reproduced or transmitted in any form or by any means without the express written permission of Tohatsu Corporation.**

# YOUR TOHATSU OUTBOARD MOTOR

---

## OWNER REGISTRATION AND IDENTIFICATION

Upon purchasing this product, be sure your dealer\* fills out the WARRANTY CARD correctly, completely and mails it to the distributor. This card identifies you as the legal owner of the product and serves as your warranty registration. If this procedure is not followed, your outboard motor will not be covered by warranty.

\* : In this manual, "dealer" always means an authorized TOHATSU dealer.

## PRE-DELIVERY CHECK

Be sure that the product has been checked by the dealer before delivery.

## Limited Warranty

This TOHATSU product is fully guaranteed against defective materials and workmanship for the period from the date of purchase, provided that the purchase has been registered in accordance with the above.

The limited warranty will not apply to the normal wear and tear of parts, adjustments, tune-ups, or to any damage caused by, but not limited to:

- 1) Use or operation NOT conforming to the instructions described in this owner's manual.
- 2) Participation in or preparation for racing or other competitive activities.
- 3) Water entering the engine.
- 4) Damage from accidents, collisions, contact with foreign materials, or submersion.
- 5) Growth of marine organisms on motor surfaces.
- 6) Any other careless use or operation.
- 7) Normal deterioration.

The limited warranty does not cover maintenance items. The following items are a few examples not covered by the limited warranty:

Spark plugs, Anode, Trim-tab, Propeller, Fuel filter, Oil filter, Carbon brush, Starter rope, Shear-pin, Split-pin, Bolt-nut-washer, Wire cable, Rubber goods: water pump impeller, oil seal, "O"-ring, fuel hose, primer bulb, vinyl tube etc.

The limited warranty will become void if the product has been altered, modified, or repaired by anyone other than a company or service firm authorized by TOHATSU.

The limited warranty will cover only your TOHATSU product and will not cover the boat the product is mounted on, the trailer, equipment, or accessories associated with the product.

---

## Serial Number

In the space below, please record the engine's serial number (indicated both on the lower motor cover and on the cylinder block). This number will come in handy in the event of theft or to help in quickly identifying the product type.

Serial Number : \_\_\_\_\_

## To You, Our Customer:

Thank you for selecting a TOHATSU product. You are now the proud owner of an excellent outboard engine that will service you for many years to come.

We would like to point out that carefree usage can only be assured on condition that this manual is read through in its entirety and the maintenance routines described later in this manual are followed carefully. Should difficulty arise with the engine, please follow the troubleshooting procedures listed at the end of this manual. If the problem persists, contact an authorized TOHATSU service shop or your dealer.

We hope you will get much enjoyment from this product and wish you good luck in your boating adventures.

**TOHATSU CORPORATION**

## NOTICE: DANGER/WARNING/CAUTION/Note

Before operating your outboard motor, be sure to thoroughly read and understand this Owner's Manual and follow all of the instructions shown. Of particular importance is information preceded by the words "DANGER," "WARNING," "CAUTION," and "Note." Always pay special attention to such information to ensure safe and trouble-free operation at all times.

### **DANGER**

Failure to observe will result in severe personal injury or death.

### **WARNING**

Failure to observe could result in severe personal injury or death.

---

## CAUTION

Failure to observe could result in personal injury, or product or property damage.

### Note:

This instruction provides special information to facilitate the use or maintenance of the outboard or to clarify important points.

## EMERGENCY STOP SWITCH

The Emergency stop switch will stall the engine when the stop switch tether is pulled out. This line can be attached to the body of the operator, effectively preventing injuries from the propeller in case he/she falls overboard.

We highly recommend use of the Emergency stop switch line. However, we would also like to point out the drawbacks of the switch. Accidental activation of the switch (such as the line being pulled out in heavy seas) could cause passengers to lose their balance and even fall overboard, or it could result in loss of power in heavy seas, strong currents, or high winds. Loss of control while mooring is another potential hazard.

To prevent such hazardous situations, the 500 mm (20 inch.) line is coiled and can be extended to a full 1,300 mm (51 inch.).

## WARNINGS

As the operator/driver of the boat, you are responsible for the safety of those aboard and those in other crafts around yours, and for following local boating regulations. Therefore you should possess thorough knowledge of correct operation of the boat, engine, and accessories. To learn about the correct operation and maintenance of the engine, please read through this manual carefully.

It is very difficult for a person standing or floating in the water to take evasive action should he or she see a power boat heading in his/her direction, even at a slow speed. Therefore, when your boat is in the immediate vicinity of people in the water, the engine should be shifted to neutral and shut off.

---

SERIOUS INJURY IS LIKELY IF A PERSON IN THE WATER MAKES CONTACT WITH A MOVING BOAT, GEAR HOUSING, PROPELLER, OR ANY SOLID DEVICE RIGIDLY ATTACHED TO A BOAT OR GEAR HOUSING.

It is the operator's responsibility to perform all safety checks and to ensure that all lubrication and maintenance instructions are complied with for safe operation. It is also the operator's responsibility to return the unit to the local dealer for periodic inspection.

Correct periodic maintenance and proper care of this outboard engine will lessen the chance of problems and keep overall operating expenses at a minimum.

## **SERVICING, REPLACEMENT PARTS & LUBRICANTS**

Only let an authorized TOHATSU service shop perform service or maintenance on this product. Be sure to use genuine parts, genuine lubricants, or recommended lubricants.

## **MAINTENANCE**

As the owner of this outboard engine, you must be acquainted with correct maintenance procedures. Please comply with all instructions concerning lubrication and maintenance, and you should return the engine to the dealer, or service shop, for periodic inspection at the prescribed intervals.

Troublefree operation cannot be expected unless the engine receives adequate periodic maintenance. If proper maintenance is performed, it is not likely that a costly repair will ever be required.

## **USE OF SERVICE SHOP**

We recommend that you use only authorized dealers to carry out all of your maintenance and repair needs.

# CONTENTS

---

	Page
<b>1. SPECIFICATIONS</b> .....	1
<b>2. NAMES OF PARTS</b> .....	2
<b>3. INSTALLATION</b> .....	3
1. MOUNTING THE ENGINE ON BOAT .....	3
<b>4. PRE-OPERATING PREPARATIONS</b> .....	4
1. GASOLINE AND ENGINE OIL .....	4
2. BREAK-IN .....	6
<b>5. ENGINE OPERATION</b> .....	7
1. STARTING .....	7
2. WARMING UP THE ENGINE .....	12
3. FORWARD AND REVERSE .....	13
4. STOPPING .....	14
5. TRIM ANGLE .....	15
6. TILT UP, TILT DOWN .....	16
7. SHALLOW WATER OPERATION .....	17
<b>6. REMOVING AND CARRYING THE MOTOR</b> .....	18
1. REMOVING THE MOTOR .....	18
2. CARRYING THE MOTOR .....	18
3. STORING THE MOTOR .....	18
<b>7. TRAILERING</b> .....	19
<b>8. ADJUSTMENT</b> .....	20
<b>9. INSPECTION AND MAINTENANCE</b> .....	21
1. DAILY INSPECTION .....	22
2. PERIODIC INSPECTION .....	26
3. OFF-SEASON STORAGE .....	29
4. PRE-SEASON CHECK .....	30
5. MOTOR SUBMERGED IN WATER .....	31
6. COLD WEATHER PRECAUTIONS .....	31
7. CHECKING AFTER STRIKING UNDERWATER OBJECT .....	31
<b>10. TROUBLESHOOTING</b> .....	32
<b>11. TOOL KIT AND SPARE PARTS</b> .....	34
<b>12. OPTIONAL ACCESSORIES</b> .....	35
<b>13. PROPELLER TABLE</b> .....	36
<b>14. WIRING DIAGRAMS</b> .....	37

## 誤記訂正のお願い

本オーナーズマニュアル3ページ目 “2 主な仕様” “質量” の項目に印刷ミスがありましたので、下記の通り訂正を頂きたいようお願い致します。

質量 Kg S:17.5 L:18 → **S:18.4 L:19.4**

お客様には大変ご迷惑をお掛けいたしますが、何卒ご容赦いただきたくお願い致します。

## NOTICE

Due to a printing error, the value shown for : 1.SPECIFICATIONS (Page 1) “MASS” section needs to be corrected as follows,

MASS S · L kg(lb) 17.5(39) · 18(40) → **18.4(41) · 19.4(43)**

We apologize for any inconvenience.



# 1. SPECIFICATIONS

Item		MODEL	2A	3.5A
Overall Length	mm (in)		690 (27.2)	
Overall Width	mm (in)		363 (14.3)	
Overall Height	S · L mm (in)		1,026 (40.4) · 1,153 (45.4)	
Transom Height	S · L mm (in)		435 (17.1) · 562 (22.1)	
Mass	S · L kg (lb)		17.5 (39) · 18 (40)	
Output	kW (HP)		1.47 (2.0)	2.6 (3.5)
Max. Operating Range	rpm		4,500–5,500	5,000–6,000
Idle Speed in Forward Gear	rpm		1,200	
Idle Speed in Neutral Gear	rpm		1,300	
Engine Type			4-Stroke	
Number of Cylinder			1	
Bore × Stroke	mm (in)		55 × 36 (2.17 × 1.42)	
Piston Displacement	mL (Cu in)		85.5 (5.2)	
Exhaust System			Above propeller exhaust	
Cooling System			Water cooling	
Engine Lubrication			Splashing system	
Starting System			Manual starter	
Ignition System			Flywheel Magneto Digital C.D.I	
Spark Plug			NGK : DCPR6E	
Trim Position			4	
Engine Oil	mL (fl.oz.)		API SF, SG, SH or SJ FCW 10W–30/40, Approx. 300 (10)	
Gear Oil	mL (fl.oz.)		Genuine Gear Oil or API GL5, SAE #80 to #90, Approx. 180 (6.1)	
Clutch			Dog clutch system (F-N)	
Fuel Tank Capacity	L (US gal)		1.0 (0.26) Integral tank	
Gear Reduction Ratio			2.15 (13:28)	

# 2. NAME OF PARTS

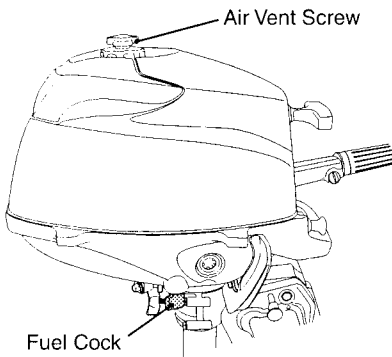
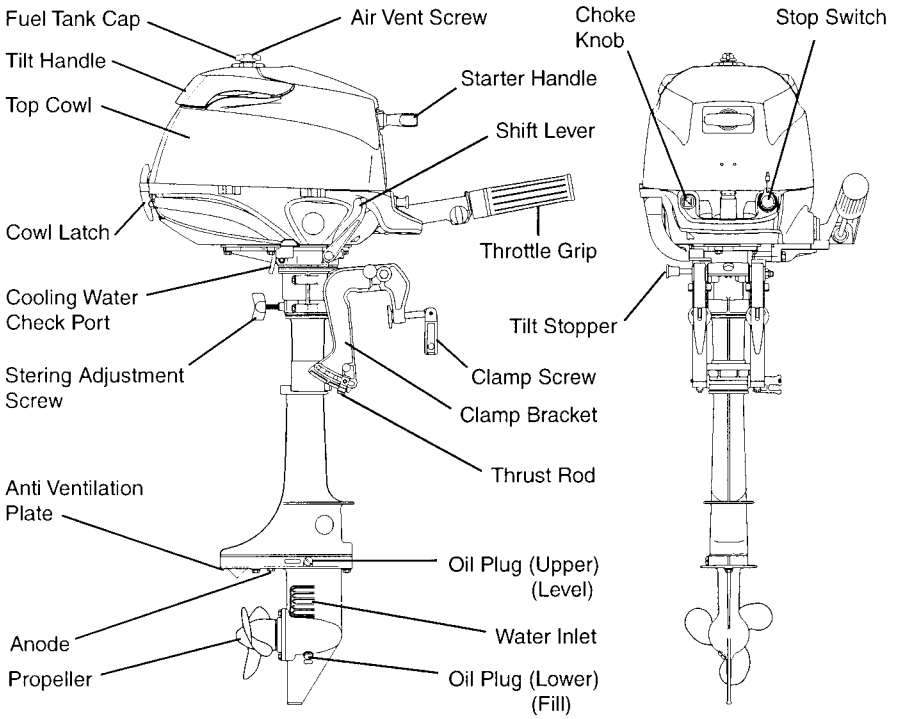

Integral Fuel Tank

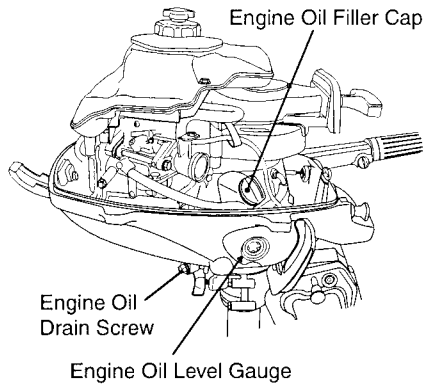

# 3. INSTALLATION

## ▲ WARNING

Most boats are rated and certified in terms of their maximum allowable horsepower, and this is shown on the boat's certification plate. Do not equip your boat with an outboard that exceeds this limit. If in doubt, contact your dealer.  
Do not operate the engine unit until it has been securely mounted on the boat in accordance with the instructions below.

### 3-1. Mounting the engine on boat

(1) Position . . . above keel line

● Set engine at center of boat.

(Fig. 1)

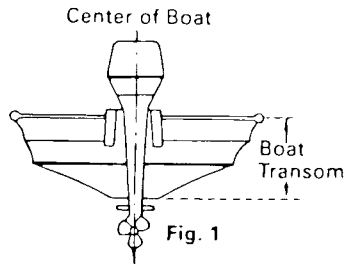

(2) Transom matching

Be sure that the antiventilation plate of the outboard is below the water surface. (Fig. 2)

If the above condition cannot be met due to the shape of the bottom of your boat, please consult your dealer.

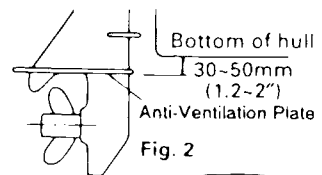

(3) To attach the engine to the boat, tighten the clamp screws by turning their handles.

(Fig. 3)

Secure with a cable, or rope, to prevent loss overboard.

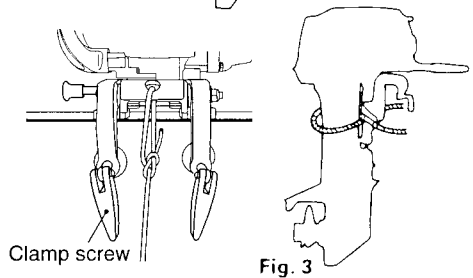

## ▲ WARNING

If the length of security line being used is long enough to allow the outboard to disengage off the boat transom but is too short to not allow the outboard to submerge behind the boat and stop running, the outboard could continue running and propel itself back into the boat with the propeller rotating under power. This exposes the occupants to serious injury or death.

# 4. PRE-OPERATING PREPARATIONS

## 4-1. Gasoline and engine oil

### **DANGER**

Gasoline vapors are present, an errant spark could cause an explosion or fire.

- Do not smoke near gasoline.
- Do not overfill gasoline tank.  
If any gasoline is spilt, wipe it up immediately.
- Stop the engine before filling gasoline tank.

### ● **Required Gasoline types**

Unleaded, minimum pump posted 87 octane gasoline is recommended. (Octane is based on posted rating.)

(91 based on the research octane rating method)

Note:

Use of low-quality gasoline results in a short engine life as well as starting difficulties and other engine problems.

Note:

(1) Gasoline containing alcohol {methanol (methyl), or ethanol (ethyl)}, acetone or benzene, may cause:

- Wear and damage to bearings, cams, piston(s), piston rings.
- Corrosion of metal parts.
- Deterioration of rubber parts and plastic parts.
- Starting, idling, and other engine performance problems.

(2) Do not use gasoline that contains more than 10% ethanol or more than 5% methanol.

(3) Damages resulting from the use of gasolines that contain alcohol are not covered under the limited warranty.

## ● Engine Oil

Use only high quality 4-stroke engine oil to insure performance and prolonged engine life.

Use only oils that carry the API rating of SF, SG, SH or SJ. Select the appropriate viscosity, based on atmospheric temperature, from the chart below.

You can also use NMMA FCW certified 4-stroke outboard oil below.

- 10W-30: is recommended for use in all temperature.

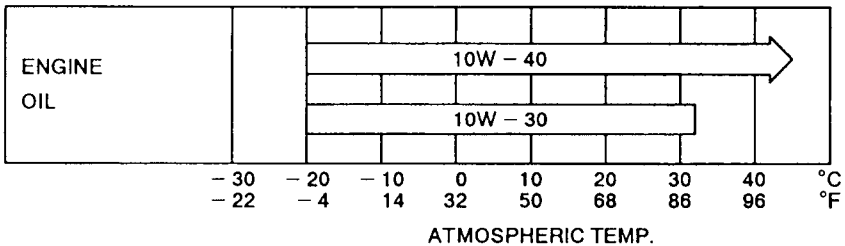

### Note:

Use of engine oils that do not meet these requirements will result in reduced engine life, and other engine problems.

### Note:

The engine oil is drained for shipping from the factory. Be sure to fill the engine to the proper level before starting engine. (To properly fill the engine with oil follow the instructions in section 9 of this manual)

---

## 4-2. Break-In

Break-in period . . . . . 10 hours

Note:  
You must break-in the engine by operating it for 10 hours according to the chart below.

Time	0	10 min.	2 hrs.	3 hrs.	10 hrs.~
<b>Method of operation</b>	Idling or trolling	Throttle open less than 1/2 of the way (about 3,000 rpm)	Throttle open less than 3/4 of the way (about 4,000 rpm)	Throttle open 3/4 of the way (about 4,000 rpm)	Normal operating
<b>Conditions</b>	Cruising at no more than minimum speed		A full-throttle run is allowed for 1 min. every 10 min.	A full-throttle run is allowed for 2 min. every 10 min.	

# 5. ENGINE OPERATION

## 5-1. Starting

### ▲ WARNING

Be sure to connect the emergency tethered stop hook to your waist or clothing.

The engine will shut down when the switch lock becomes disconnected from the engine.

#### Note:

The engine will not start unless the switch lock has been properly connect into the emmergency stop switch.

#### Note:

Do not operate the engine with gear case out of water.  
Severe personal injury, or engine damage with result.

- ① Loosen the air vent screw on the tank cap.

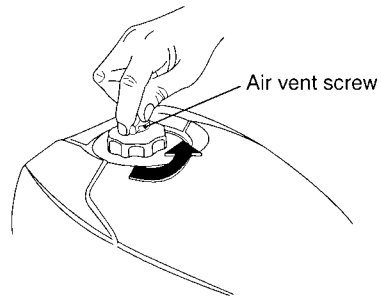

- ② Open the fuel cock.

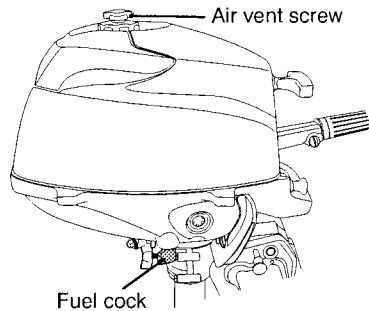

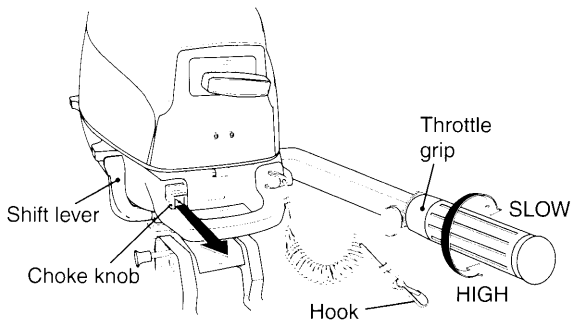

- ③ Be sure to install the stop switch lock to the stop switch and connect the coil cord to a part of the operator's body by the hook.
- ④ Make sure that the shift lever is in the Neutral position.
- ⑤ Set the throttle grip to the "START" position.

**Note:**

When the motor has been warmed up, set the throttle grip to the "RE-START" position for starting.

- ⑥ Pull the choke knob fully. (When the motor has been warmed up, it is not necessary to operate the choke knob.)

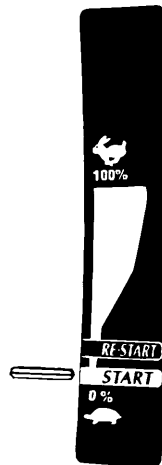



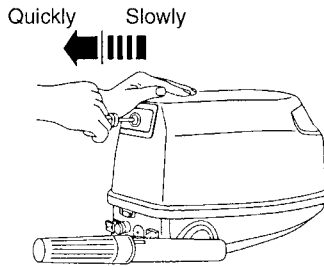

- ⑦ Gently pull the starter handle until you feel slight resistance (engagement), and then quickly and strongly pull the handle without a rest.
- ⑧ When the motor starts, push the choke knob back. (in the case the choke knob is used.)

**Note:**

When warming up the engine in cold weather, set the choke knob to half opened position if necessary.

## If the recoil starter fails to operate

- Remove the top cowl and the recoil starter.

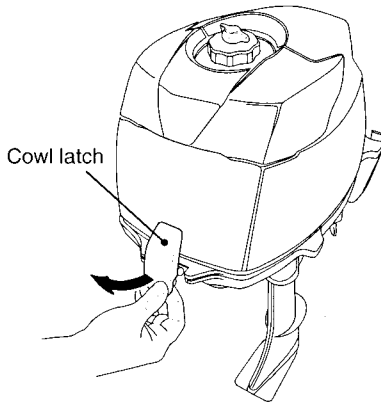

### Removing the recoil starter

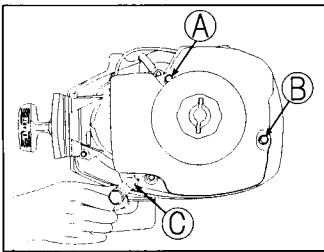

- ① Loosen the three bolts (A, B, C) fastening the tank. (Don't remove the tank fastening bolts.)

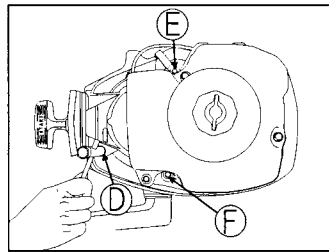

- ② Remove the three bolts (D, E, F) fastening the recoil starter.

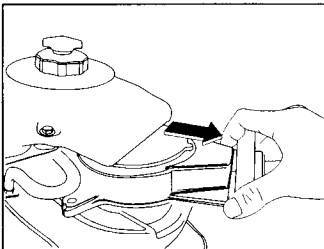

- ③ Remove the recoil starter.

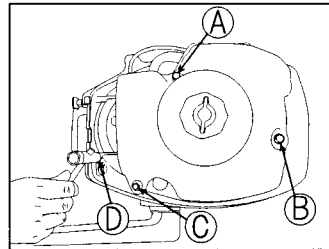

- ④ Tighten the three bolts (A, B, C) fastening the tank and one bolt (D) fastening the recoil starter.

- Confirm that the shift lever is at “N” (neutral) position.
- Wind the rope clockwise around the starter pulley then pull quickly to start.
- Use a 10 mm socket wrench as a rope handle.

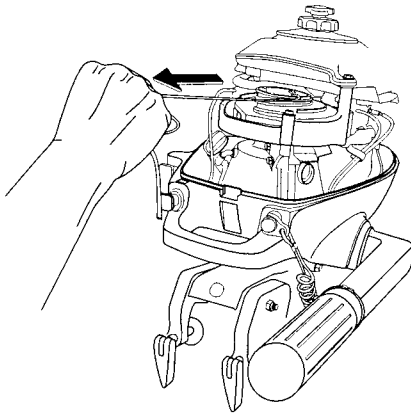

## **⚠ CAUTION**

Be careful that your clothes or other items do not get caught in the rotating engine parts.

To prevent accident and injury, do not re-attach the recoil starter after the engine has been started using the emergency starter rope. Be sure to put the top cowl back on.

Immediately contact an authorized service shop when reaching shore.

## 5-2. Warming up the engine

Warm the engine at low engine speeds for about three minutes. This allows the lubricating oil to circulate to all parts of the engine. Operating the engine without warm up shortens the engine's life.

Be sure to check that cooling water is coming out of the cooling water check port during warm up.

### ▲ CAUTION

If the engine is operated without water discharging from the check port, the engine may over heat.

#### ● Engine speeds

Idling speed after warming up.

Clutch in	Clutch off
1,200 rpm	1,300 rpm

#### PROPELLER SELECTION

Propeller must be selected that will allow the engine to reach recommended rpm when cruising at wide-open throttle.

Wide-open throttle rpm range	
2	3.5
4,500—5,500 rpm	5,000—6,000 rpm

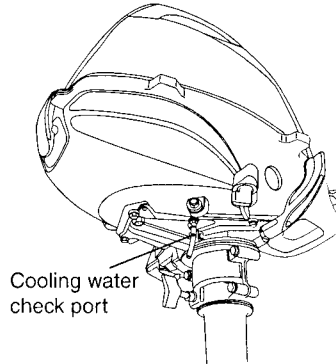

Genuine propellers are listed on PROPELLER TABLE of this manual.

#### ESG (A device preventing over revolution)

ESG is a device to prevent over revolution of the engine (more than approximately 6,300 rpm).

If you sense that the ESG is activated return to shore at a reduced speed (rpm).

Possible causes of ESG activation are: Worn, broken, bent propeller. Making sharp turns at high speeds.

### 5-3. Forward and reverse

#### **⚠ WARNING**

Severs damage, and personal injury, may occur if shifting at high engine speed.  
Engine must be in the slow running position before shifting is attempted.

#### **⚠ CAUTION**

The shear pin breaks when the propeller is shocked, otherwise, the shear pin may break if shifting is done at a high motor speed.

Note: When moving astern, be sure to operate the motor at a low speed without unnecessary increase of the motor speed.

Motor operation mode for moving ahead and astern can be shifted by the shift lever.

(1) Forward

Turn the throttle grip to the low speed position. As soon as the engine speed turns down to the lowest, quickly pull the shift lever to the "F" (Forward) side.

(2) Reverse

Turn the engine speed to the lowest in the same manner as the operation for moving ahead. After setting the shift lever to the "N" (Neutral) position and the handle upright, turn the outboard motor at an angle of 180° and quickly turn the shift lever to the "F" (Forward) side.

(3) Driving in shallows

When driving in shallows, operate the motor at the lowest speed paying careful attention to the depth of the water and obstacles.

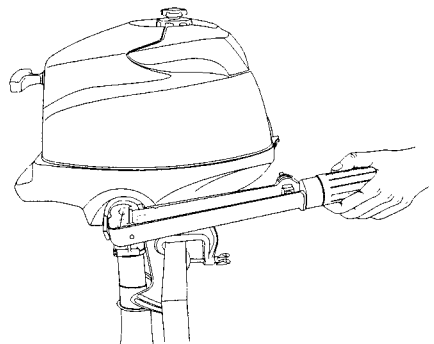
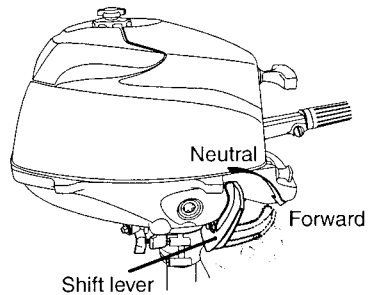

---

## 5-4. Stopping

- ① Turn the throttle grip to the low speed position.
- ② Set the shift lever to the “N” (Neutral) position.  
After high-speed operation, continue idling for 2 to 3 minutes.
- ③ Continue pressing the stop switch until the motor stops.  
Or pull the stop switch lock out.
- ④ Tighten the air vent screw of the tank cap.
- ⑤ Close the fuel cock.

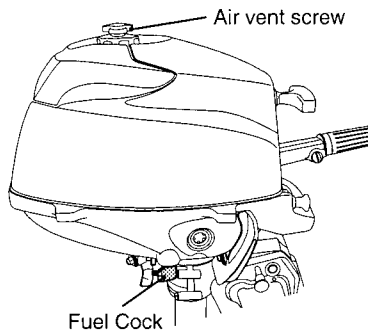
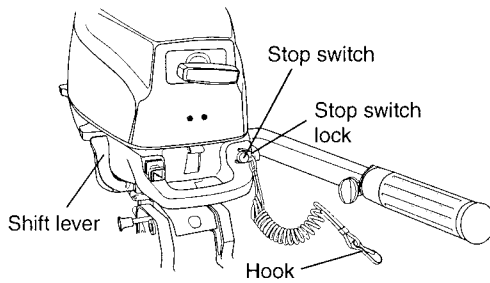

Note:

- After stopping the engine, close the air vent screw on the tank cap.
- Close the fuel cock. (Integral fuel tank)

## 5-5. Trim angle

The trim angle of the outboard motor can be adjusted to suit the transam angle of the hull, and load conditions. Choose an appropriate trim angle that will allow the anti-ventilation plate to run parallel to the water surface during operation.

### ● Proper trim angle

The position of the thrust rod is correct if the hull is horizontal during operation. (Fig. 1)

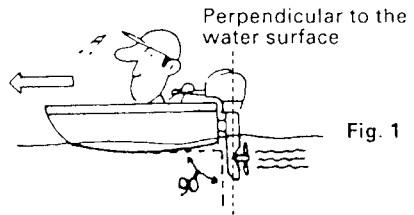

### ● Improper trim angle (bow rises too high)

Set the thrust rod lower if the bow of the boat rises above horizontal. (Fig. 2)

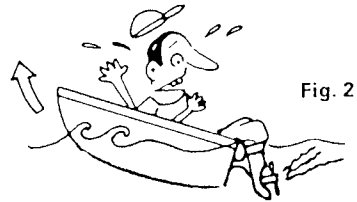

### ● Improper trim angle (bow dips into the water)

Set the thrust rod higher if the bow of the boat is below horizontal. (Fig. 3)

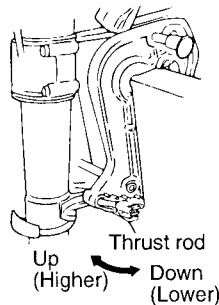
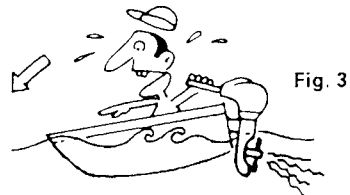

## 5-6. Tilt up, tilt down

### **⚠ WARNING**

When tilting up or down, be careful not to place your hand between the swivel bracket and the stern bracket.  
Be sure to tilt the outboard down slowly.

### **⚠ CAUTION**

Be sure to stop the motor during tilt-up or tilt-down operation.

#### (1) Tilt up

- ① Close the fuel cock and tighten the air vent screw of the tank cap.
- ② Tilt up the outboard motor fully to your side and press the tilt stopper inside to set it up.

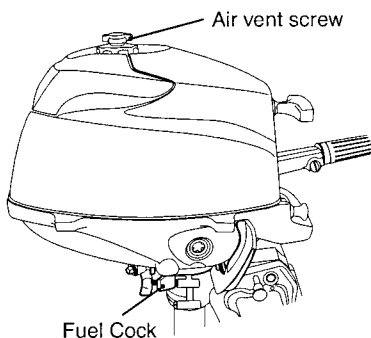

#### (2) Tilt down

Pull the outboard motor to your side and draw the tilt stopper knob out for tilting down.

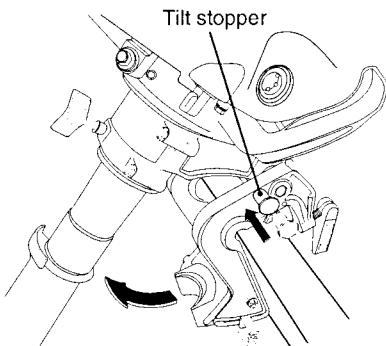



---

## 5-7. Outboard motor position in tilt-up

When the outboard motor is in the tilt-up position, the tilt handle side must be in the upward direction (the starter handle side must look downward).

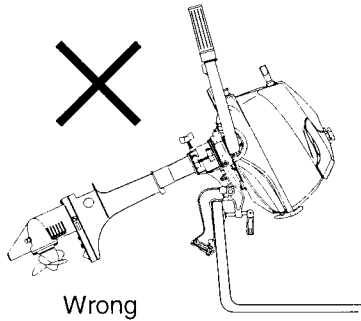
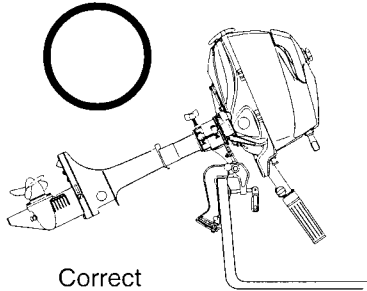

### **⚠ CAUTION**

The outboard motor is set in the correct tilt-up position in the usual condition, however, the outboard motor may be set in the wrong tilt-up position if the motor direction is sharply changed in course of tilting up.

If the outboard motor is set in a wrong position, try to tilt it up once more to set it in the correct position.

## 6. REMOVING AND CARRYING THE MOTOR

### 6-1. Removing the motor

- ① Stop the engine, close the air vent screw.
- ② Close the fuel cock.
- ③ Remove the motor from boat and completely drain the water from the gear case.

### 6-2. Carrying the motor

Keep the motor in a vertical position when carrying.

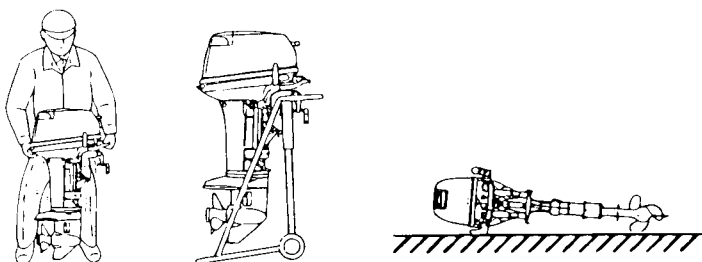

### 6-3. Storing the motor

Motor should be stored in a vertical position.

Note:

If the engine must be laid down be sure the tiller handle faces up (The shift lever down) as shown in the drawing above.

## ⚠ CAUTION

Never carry, or store, the engine in the positions shown below.

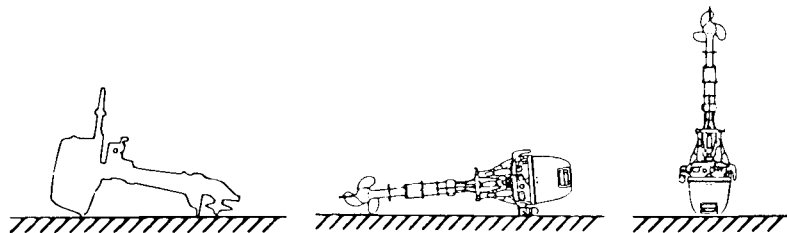

# 7. TRAILERING

## **⚠ CAUTION**

When trailering the engine should be in a vertical (normal running) position, fully down. Trailering in the tilted position may cause damage to the motor, boat, etc.

If trailering with engine fully down is not available (the gear case skeg is too close to the road in a vertical position), fix the motor securely using a device (like a transom saver) in the tilted position.

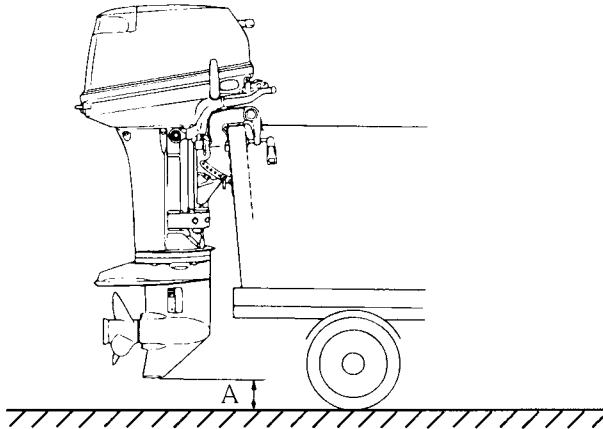

A: Ground clearance should be provided sufficiently.

## **⚠ CAUTION**

The tilt support device supplied on your outboard is not intended for towing. It is intended to support the engine while the boat is docked, beached, etc.

# 8. ADJUSTMENT

## 8-1. Steering friction

The steering friction can be adjusted in accordance with your preference by turning the adjustment screw.

For heavier steering . . . . . Turn clockwise

For lighter steering . . . . . Turn counterclockwise

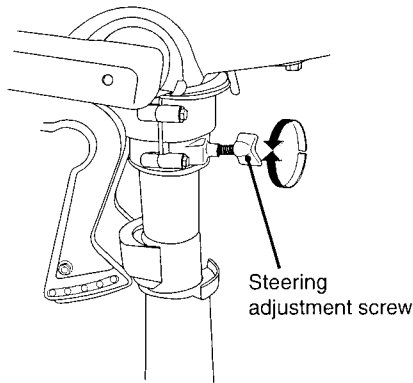

**Note:**

The steering adjustment screw is used to adjust the friction load of the steering, but not to fix the steering. Excess tightening of the adjustment screw may cause damage to the swivel bracket.

## 8-2. Throttle grip

Friction adjustment of the throttle grip can be made with the throttle adjustment screw.

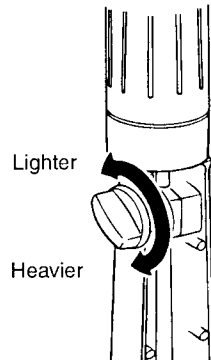

# 9. INSPECTION AND MAINTENANCE

---

## Care of your outboard motor

To keep your motor in the best operating condition, it is very important that you perform daily and periodic maintenance as suggested in the maintenance schedules that follow.

### CAUTION

- Your personal safety and that of your passengers depends on how well you maintain your outboard motor. Carefully observe all of the inspection and maintenance procedures described in this section.
- The maintenance intervals shown in the checklist apply to an outboard motor in normal use. If you use your outboard motor under severe conditions such as frequent full-throttle operation, frequent operation in brackish water, or for commercial use, maintenance should be performed at shorter intervals. If in doubt, consult your dealer for advice.
- We strongly recommend that you use only genuine replacement parts on your outboard motor. Damage to your outboard arising from the use of other than genuine parts is not covered under the warranty.

## EPA Emissions Regulations

EPA (United States Environmental Protection Agency) has emission regulations and controlling air pollution from new outboard motors. All new motors manufactured by us are certified to EPA as conforming to the requirements of the regulations. This certification depends upon factory standards. Therefore, factory specifications must be followed when servicing emission related controls, or making adjustments. **Maintenance, replacement, or repair of the emission control devices and systems may be performed by any marine SI (Spark Ignition) engine repair establishment or individual.**

## 9-1. Daily Inspection

Perform the following checks before and after use.

Item	Points to Check	Action
Fuel System	<ul style="list-style-type: none"> <li>● Check the amount of fuel in the tank.</li> <li>● Check for debris in the fuel filters.</li> <li>● Check the rubber hoses for fuel leakage.</li> </ul>	Fill fuel Clean or Replace Replace
Engine Oil	<ul style="list-style-type: none"> <li>● Check the oil level.</li> </ul>	Fill to the upper level mark.
Electrical Equipment	<ul style="list-style-type: none"> <li>● Check that the stop switch functions normally and make sure the lock plate is in right location</li> <li>● Check cords for loose connections and damage.</li> <li>● Check the spark plug for dirt, wear and carbon build-up.</li> </ul>	Remedy or replace  Correct or replace  Clean or replace
Throttle System	<ul style="list-style-type: none"> <li>● Check that the carburetor choke valve functions normally.</li> <li>● Check carburetor linkage is working normally when turning the throttle grip.</li> </ul>	Replace  Correct
Recoil Starter	<ul style="list-style-type: none"> <li>● Check the rope for wear and chafing.</li> <li>● Check the ratchet engagement.</li> </ul>	Replace Correct or replace
Clutch and Propeller System	<ul style="list-style-type: none"> <li>● Check that the clutch engages correctly when operation the shift lever.</li> <li>● Visually check the propeller for bent or damaged blades.</li> <li>● Check that the split pin is on the propeller.</li> </ul>	Adjust  Replace
Installation of Motor	<ul style="list-style-type: none"> <li>● Check the clamp screws attaching the motor to the boat for tightness.</li> <li>● Check the thrust rod installation.</li> </ul>	Tighten
Cooling Water	<ul style="list-style-type: none"> <li>● Check that cooling water is discharged from the cooling water check port after the engine has started.</li> </ul>	
Tools and Spares	<ul style="list-style-type: none"> <li>● Check that there are tools and spare parts for replacing spark plugs, the propeller, etc.</li> <li>● Check that you have the spare rope.</li> </ul>	
Other parts	<ul style="list-style-type: none"> <li>● Check if the anode is securely installed.</li> <li>● Check the anode for corrosion and deformation.</li> </ul>	Repair if necessary Replace

## A. Maintaining engine oil

If the engine oil level is low, the life of the engine will be shortened significantly.

Checking oil level:

- ① Stop the engine and set it in a vertical position.
- ② Remove the top cowl.
- ③ Check the oil level by the oil level gauge.

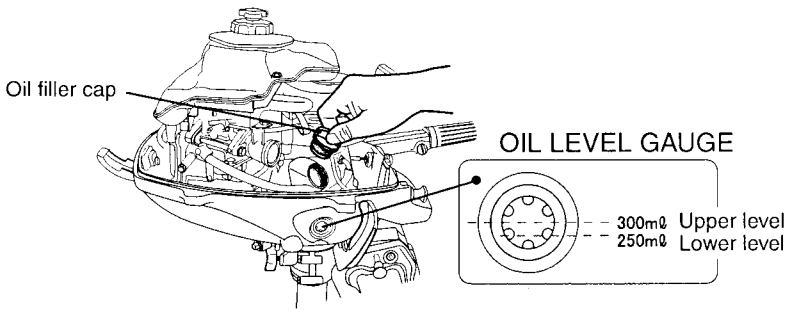

Note:

Consult with your dealer if the engine oil is milky color, or appears contaminated.

Filling engine oil:

If the oil level is low, or at lowest mark, add recommended oil to the upper level mark .

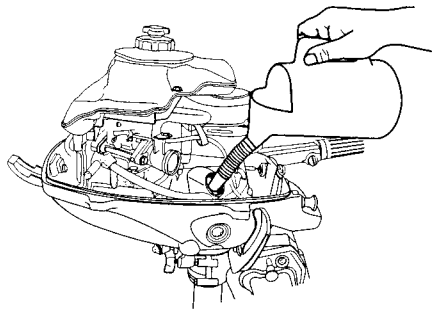

### **▲ CAUTION**

- When adding engine oil, use the same brand and same grade oil.
- Be careful not to mix dust and water when adding the engine oil.
- If the oil over flows, wipe it up with rag.

## B. Flushing

After operating the motor in sea water or polluted water, or if it will be stored for a long period, flush all enclosures and the water cooling system with fresh water.

### **▲ WARNING**

Before flushing, remove the propeller.

### **▲ WARNING**

Never start or operate the engine indoors or in any space which is not well ventilated. Exhaust gas contains carbon monoxide, a colorless and odorless gas which can be fatal if inhaled for any length of time.

- Remove the water plug from the motor, and screw in the flushing attachment. Connect a hose to the flushing attachment.
- With the shift lever in “N” (Neutral) , run the engine at a low speed while flusing the cooling system to ensure all sea water and mud are removed.

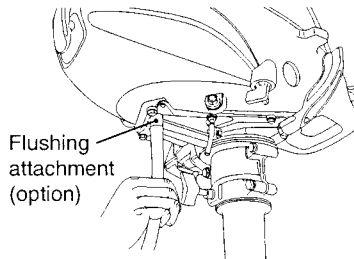

## C. Replacing the propeller and shear pin

A worn-out or bent propeller will lower the motor's performance, and cause engine trouble.

### **▲ CAUTION**

Before removing the propeller, remove the spark plug cap from the spark plug to protect against personal injury.



- ① Pull out the split pin from the propeller boss and remove the propeller from the shaft.
- ② Remove the shear pin from the shaft.
- ③ Install a new shear pin.

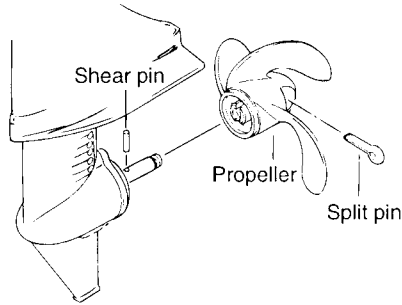

## D. Replacing the spark plug

If the spark plug is fouled, has carbon build up, or is worn, it should be replaced.

- ① Stop the engine.
- ② Remove the top cowl.
- ③ Remove the spark plug cap.
- ④ Remove the spark plug by turning it counter-clockwise, using a 16 mm socket wrench and handle.

Use spark plug NGK : DCPR6E.

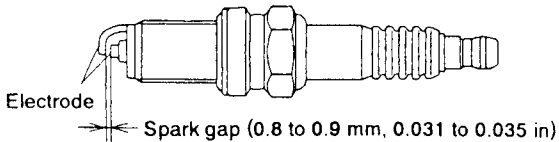

## E. Replacing the anode

A sacrificial anode protects the outboard from the galvanic corrosion. Anode is located on the gear case. When the anode is eroded more than 2/3, replace it.

Note:

- Never grease or paint the anode.
- At each inspection re-tighten the anode attaching bolt. As it is likely to be subjected to electrolytic corrosion.

## 9-2. Periodic Inspection

It is important to inspect and maintain your outboard motor regularly. At each interval on the chart below, be sure to perform the indicated servicing. Maintenance intervals should be determined according to the number of hours or number of months, whichever comes first.

Item		Servicing Interval			Action	Remarks
		First 20 hours or 1 month	Every 50 hours or 3 months	Every 100 hours or 6 months		
Fuel System	*Carburetor			○	Clean, and adjust.	
	Fuel filter	○	○	○	Check and clean or Replace.	
	Piping	○	○	○	Check and Replace.	
	Fuel tank	○		○	Clean	
Ignition	Spark plug	○		○	Check gaps. Remove carbon deposits or Replace.	0.8 – 0.9mm (0.031 – 0.035 in)
Starting System	Starter rope	○	○	○	Check for wear or chafing.	
Engine	Engine oil	○		○	Replace	
	Valve Clearance	○		○	Check & adjust.	
Lower Unit	Propeller	○	○	○	Check for bent blades, damage, wear.	
	Shear pin and split pin	○	○	○	Check or Replace	
	Gear oil	Replace ○	○	Replace ○	Replace or Fill gear oil and check for water leaks.	180 mL (6.1 fl. oz)
	*Water pump		○	○	Check for wear or damage.	Replace impeller every 12 months.
Bolts and Nuts		○	○	○	Retighten	
Sliding and Rotating Parts. Grease Nipples.		○	○	○	Apply and pump in grease.	
Outer Equipment		○	○	○	Check for corrosion.	
Anode			○	○	Check for corrosion and deformation.	Replace

\* Have this handled by the dealer.

### Note:

Your outboard motor is recommended to receive careful, and complete, inspection at 300 hours. This is the best time for major maintenance procedures to be carried out.

## A. Replacing engine oil

Engine oil mixed with dust and water will remarkably shorten the life of the engine.

To replacing engine oil:

- ① Stop the engine and set it in a vertical position.
- ② Remove the top cowl and oil filter cap. Allow it to cool.
- ③ Put a oil drain pan under the oil drain screw.
- ④ Remove the oil drain screw and completely drain oil from the engine.
- ⑤ Tighten the oil drain screw.
- ⑥ Fill the engine through filler port with recommended oil (see chart below) to the upper level mark.
- ⑦ Tighten the oil filler cap.

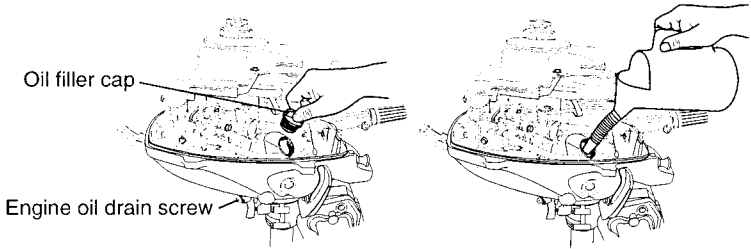

(Note)

Recommended engine oil:

4 stroke engine oil . . . . . Use FCW 10W-30/40 of rated SF, SG, SH or SJ. Use the proper viscosity oil from the chart below. This chart is based on the atmospheric temperature where the engine will be used.

Oil capacity . . . . . 300 mL

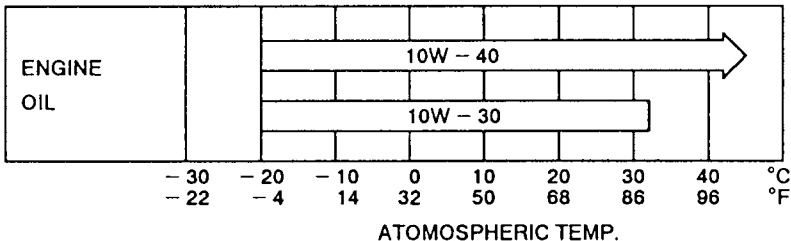

## **⚠ CAUTION**

You may be injured due to high engine temperatures. If you fill engine oil just after stopping. Changing engine oil should be done after the engine has been cooled.

Note:

- If water in the oil, giving it a milky colored appearance. Contact your dealer.
- If oil contaminated with fuel will smell strongly of fuel. Contact your dealer.

### **B. Replacing gear oil**

- 1) Remove the oil plugs (upper and lower), and completely drain the gear oil into a pan.

Note:

- If water in the oil, giving it a milky colored appearance. Contact your dealer.

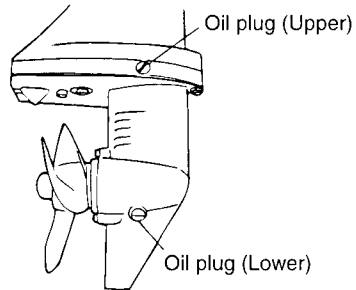

- 2) Insert the oil tube nozzle into the lower oil plug hole, and fill with gear oil by squeezing the oil tube until oil flows out of the upper plug hole.

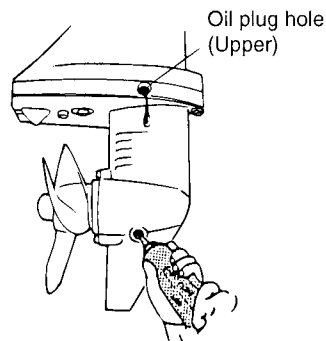

- 3) Install the upper oil plug, and then remove oil tube nozzle and install the lower oil plug.

Note:

Use genuine gear oil or the recommended one (API GL-5: SAE #80 to #90).

Required volume: approx. 180 mL.

---

### 9-3. Off-season storage

To put your outboard motor in storage, it is a good opportunity to have it serviced and prepared your dealer.

#### CAUTION

Before servicing the motor for storage:

- Remove the spark plug cap from the spark plug.
- Do not run the motor out of the water.

- ① Wash the engine exterior and flush the cooling water system thoroughly with fresh water. Drain the water completely.  
Wipe off any surface water with an oil rag.
- ② Use a dry cloth to completely wipe off water and salt from the electrical components.
- ③ Drain all fuel from the fuel hoses, and carburetor, and clean these parts.  
Keep in mind that if gasoline is kept in the carburetor for a long time, gum and varnish will develop, causing the float valve to stick, restrict the jets.
- ④ Remove the spark plug and spray storage oil (available from your authorized dealer) into the combustion chamber through the spark plug hole while slowly turning the motor over using the recoil starter.
- ⑤ Change the engine oil.
- ⑥ Change the gear oil in the gear case.
- ⑦ Apply grease to the propeller shaft.
- ⑧ Apply grease to all sliding parts, joints, nuts, and bolts.
- ⑨ Stand the engine up vertically in a dry place.

---

## 9-4. Pre-season check

Check that the shift and throttle function properly.

(Be sure to turn the propeller shaft when checking the shift function or else the shift linkage may be damaged.)

**Note:**

The following steps must be taken when first using the engine after winter storage.

1. Fill the fuel tank completely with 1.0 liters.
2. Warm up the engine for 3 minutes in the "N" (NEUTRAL) position.
3. Run the engine for 5 minutes at the slowest speed.
4. Run the engine for 10 minutes at half speed.

In Steps 2 and 3 above, the oil used for storage inside the engine will be flushed out to assure optimum performance.

---

## **9-5. Motor submerged in water**

After taking your motor out of the water, immediately take it to your dealer.

The following are the emergency measures to be taken for a submerged outboard, if you can not take it to your dealer right away.

- 1) Wash the motor with fresh water to remove salt or dirt.
- 2) Remove the engine oil drain screw and completely drain water and oil from the engine.
- 3) Remove the spark plug, and completely drain the water from the engine by pulling the recoil starter several times.
- 4) Inject a sufficient amount of engine oil through the spark plug hole. Pull the recoil starter several times to circulate the oil throughout the motor.

## **9-6. Cold weather precautions**

If you moor your boat in cold weather at temperatures below 0°C (32°F), there is the danger of water freezing in the cooling water pump, which may damage the pump, impeller, etc. To avoid this problem, submerge the lower half of the engine into the water.

## **9-7. Checking after striking underwater object**

Striking the sea bottom or an underwater object may severely damage the outboard. Immediately bring the outboard to the dealer and ask for the following checks.

- (1) Looseness or damage of power unit installation bolts, gear case and extension case bolts, propeller shaft housing bolts, upper and lower mount rubber bolts, and/or mount bracket bolts.

Ask the dealer to tighten any loose bolts any nuts, and to replace damaged parts.

- (2) Damage to mount rubber, the tilt stopper, thrust rod, gears and clutch, and/or propeller.

Ask the dealer to replace damaged or defective parts.

# 10. TROUBLESHOOTING

If you encounter a problem, consult the check list below to determine the cause and to take the proper action.

Your dealer will always be happy to provide any assistance and information.

	Engine failing to start	Engine starting but stopping soon	Poor idling	Poor acceleration	Engine speed abnormally high	Engine speed abnormally low	Boat speed low	Overheating of engine	Possible cause
FUEL SYSTEM	●	●							Empty fuel tank
	●	●	●	●		●	●		Deformed or damaged fuel hose
	●	●	●	●		●	●	●	Closed air vent on fuel tank
	●	●	●	●		●	●	●	Clogged fuel filter, fuel pump, or carburetor
			●	●		●	●	●	Use of improper engine oil
	●	●	●	●			●	●	Use of improper gasoline
	●			●					Excessive supply of fuel
	●	●	●	●		●	●	●	Poor carburetor adjustment
ELECTRIC SYSTEMS	●	●	●	●		●	●	●	Spark plug other than specified
	●	●	●	●		●	●		Dirt, soot, etc. on spark plug
	●	●	●	●		●	●		No spark or weak spark
	●								Short circuit of engine stop switch



		Engine failing to start	Engine starting but stopping soon	Poor idling	Poor acceleration	Engine speed abnormally high	Engine speed abnormally low	Boat speed low	Overheating of engine	Possible cause
ELECTRIC SYSTEMS	●		●	●		●	●		Ignition timing incorrect	
	●								Lock plate not fitted to stop switch	
	●								Disconnection of wire or loose ground connection	
OTHERS	●		●	●		●	●		Incorrect adjustment of throttle link	
							●	●	Insufficient cooling water flow, clogged or defective pump	
			●				●	●	Faulty thermostat	
				●	●		●	●	Cavitation or ventilation	
				●	●	●	●	●	Incorrect propeller selection	
			●	●	●	●	●	●	Damaged and bent propeller	
				●	●		●	●	Improper thrust rod position	
				●	●	●	●	●	Unbalanced load on boat	
				●	●	●	●	●	Transom too high or too low	
		●	●	●		●			Low compression	
			●					●	Carbon deposits in the combustion chamber	
Engine makes noise									Too much the valve clearance	

# 11. TOOL KIT AND SPARE PARTS

The following a list of the tools and spare parts provided with the motor.

Items		Quantity	Dimensions	
Service tools	Tool bag	1		
	Pliers	1		
	Socket wrench	1	10 × 13 mm	
	Socket wrench	1	16 mm	
	Socket wrench handle	1		
	Screwdrivers	1	Cross- and straight-point	
	Screwdriver handle	1		
Spare parts	Starter rope	1	1,000 mm	
	Spark plug	1	NGK : DCPR6E	
	Shear pin	1		
	Split pin	1		

# 12. OPTIONAL ACCESSORIES

---

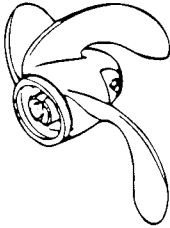

Propeller

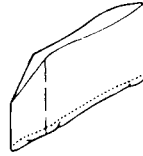

Vinyl motor cover



Genuine engine Oil  
( 1 L)

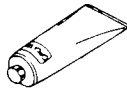

Genuine grease  
(250g)

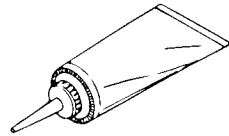

Genuine gear Oil  
(500mL)

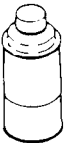

Touch-up paint  
(300mL)



Flushing attachment

# 13. PROPELLER TABLE

Use a genuine propeller.

A propeller must be selected so that the engine rpm measured at wide open throttle while cruising is within the recommended range.

2 : 4,500 to 5,500 rpm

3.5 : 5,000 to 6,000 rpm

	Propeller Mark	Propeller Size Diameter × pitch	Material	Remarks
Light boats	7	3 × 188 × 178 mm 3 × 7.4 × 7.0 inch	Plastics	Standard
	6	3 × 188 × 145 mm 3 × 7.4 × 5.7 inch	Plastics	Option
Aluminum			Option	
Heavy boats	4.5	3 × 188 × 110 mm 3 × 7.4 × 4.3 inch	Plastics	Option

Note: Each size shows number of propeller blades × diameter × pitch.

# 14. WIRING DIAGRAM

---

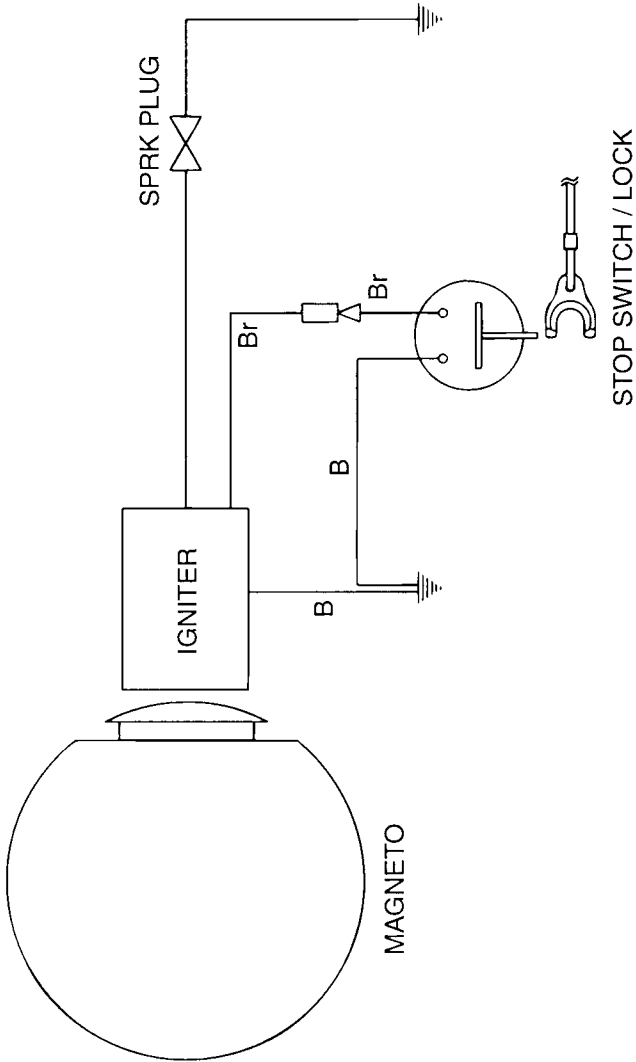

---

memo

**TOHATSU CORPORATION**

**Address : 5-4,3-chome,Azusawa,Itabashi-ku,  
TOKYO,174-0051 JAPAN**

**Phone : TOKYO (03)3966-3117**

**FAX : TOKYO (03)3966-2951**

**E-mail : [www.tohatsu.co.jp](http://www.tohatsu.co.jp)**

**OWNER'S MANUAL**

**MFS 2  
3.5**